

Artikel 2 x enthalten!

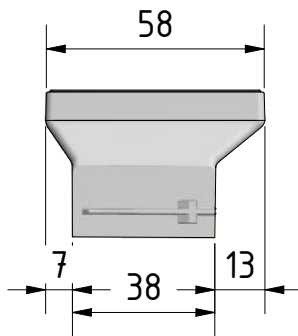

Artikel 2 x enthalten!

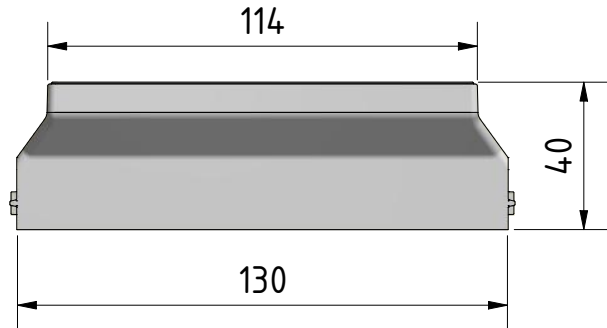
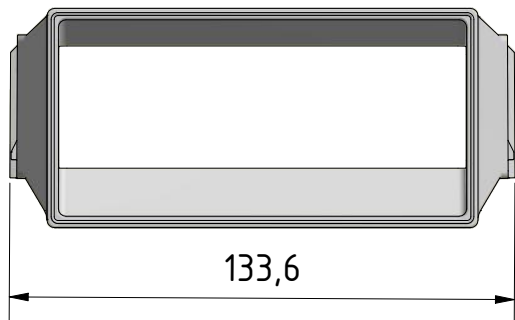
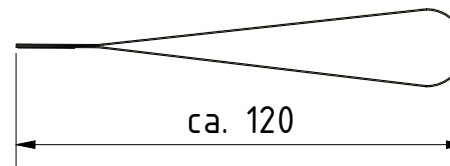
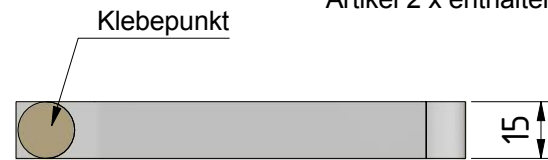

Dichtung

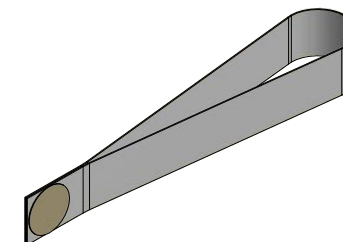
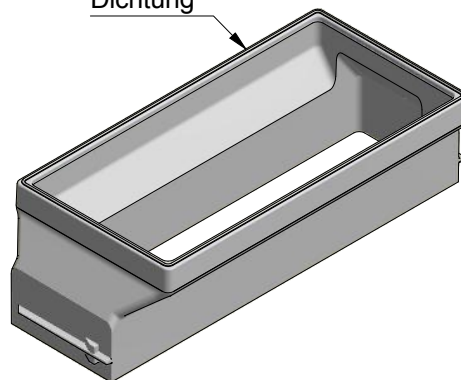

( 1 : 2 )

				DATUM	Name		
				Gezeichnet	09.07.2019	M.Corvin	M-WRG-II U <sup>2</sup> AK Adapter-Kit U <sup>2</sup>
				Kontrolliert			
				Norm			
						731001	
Status	Änderungen	DATUM	Name			A4	

LÜFTUNG & WÄRMERÜCKGEWINNUNG